

1/2" BOLT TYP

CLOSED PICK

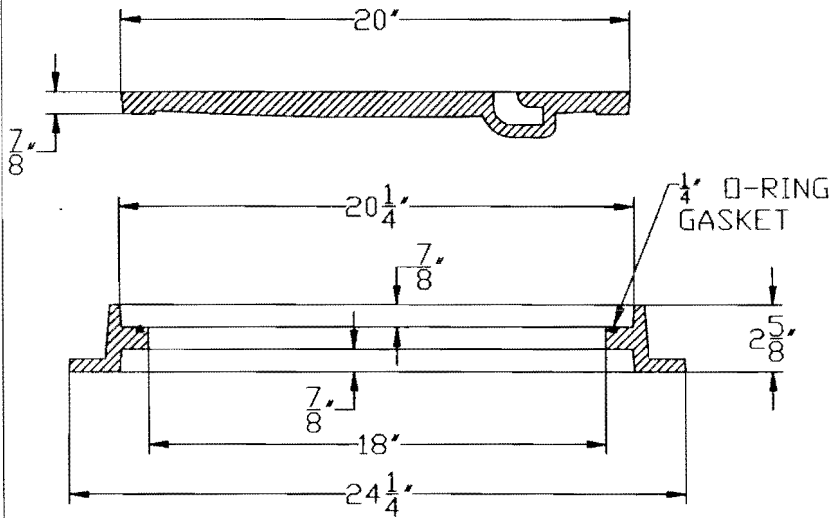
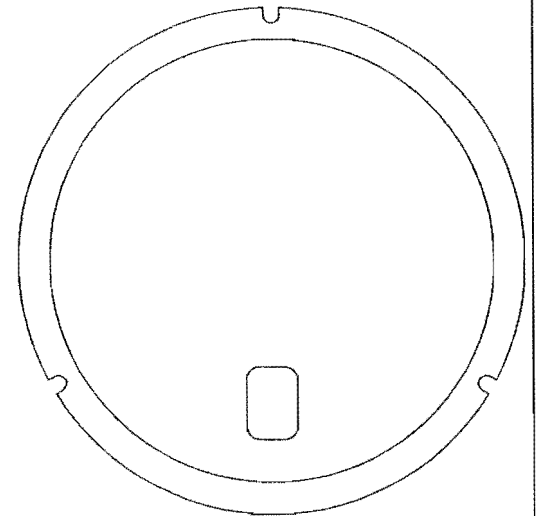

WEIGHT:  
COVER: 71 LBS  
RING: 51 LBS

CAST IRON  
TO CONFORM TO  
ASTM A-48, CLASS 30B  
MEETS H-20 LOAD RATING

B-5106

D&L MODEL #

DRAWN BY: ADAM KROUPA  
D&L Foundry (Not to Scale)

DATE: 8-30-07

**D&L** FOUNDRY & SUPPLY

CALIFORNIA SALES: (800)-422-0848  
WASHINGTON SALES: (888)-765-0054  
UTAH SALES: (800)-453-9802